

MIRAGLIO

ALZACRISTALLI PER VEICOLI INDUSTRIALI

WINDOW REGULATORS FOR TRUCKS

FENSTERHEBER ZUM LASTWAGEN

LEVE-VITRES POUR VÉHICULES INDUSTRIELS

ELEVALUNAS PARA VEHÍCULOS INDUSTRIALES

www.algogroup.net

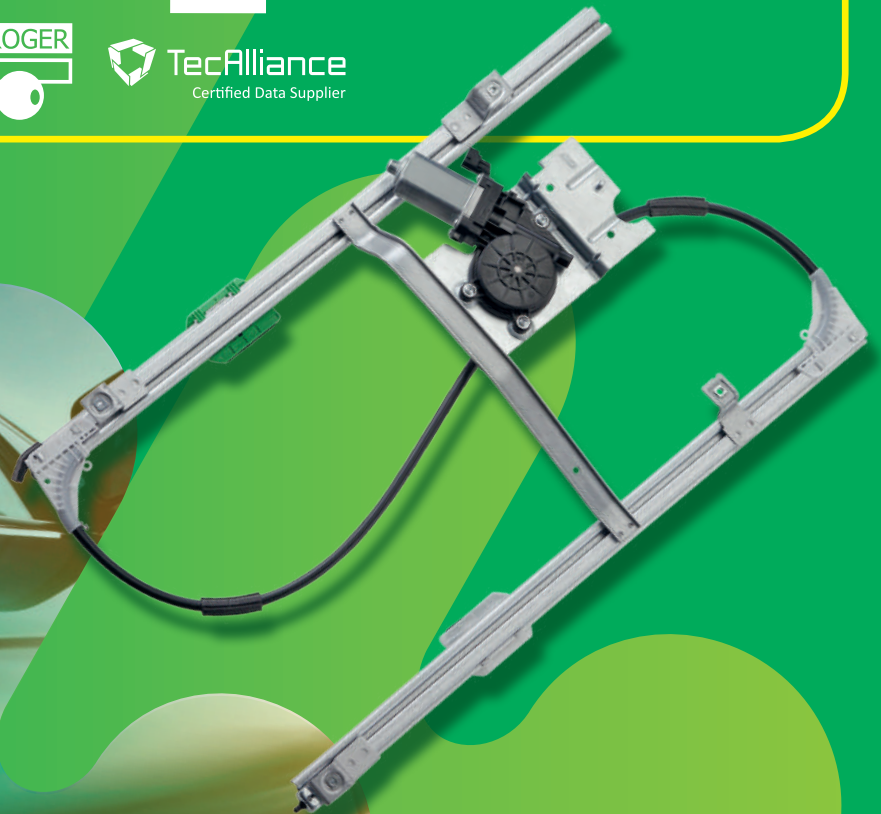



MIRAGLIO

- ALZACRISTALLI ELETTRICI
- ELECTRIC WINDOW REGULATORS
- ELEKTRISCHE FENSTERHEBER
- LEV-VITRES ELECTRIQUES
- ELEVALLINAS ELECTRICOS
- ELEVADOR DE VIDRO ELÉCTRICO
- ELEKTRISCHE RAAMMECHANISMEN
- ELEKTRICZNE PODNOŠNIKI SZYB
- НАЕКТРИКАДНАРАЧНА

www.miraglio.it

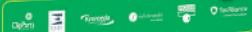

MIRAGLIO

- ALZACRISTALLI ELETTRICI
- ELECTRIC WINDOW REGULATORS
- ELEKTRISCHE FENSTERHEBER
- LEV-VITRES ELECTRIQUES
- ELEVALLINAS ELECTRICOS
- ELEVADOR DE VIDRO ELÉCTRICO
- ELEKTRISCHE RAAMMECHANISMEN

MIRAGLIO

- ALZACRISTALLI ELETTRICI
- ELECTRIC WINDOW REGULATORS
- ELEKTRISCHE FENSTERHEBER
- LEV-VITRES ELECTRIQUES
- ELEVALLINAS ELECTRICOS
- ELEVADOR DE VIDRO ELÉCTRICO
- ELEKTRISCHE RAAMMECHANISMEN
- ELEKTRICZNE PODNOŠNIKI SZYB
- НАЕКТРИКАДНАРАЧНА

www.miraglio.it



ALGO GROUP

ALGO Group, con **oltre 40 anni di esperienza**, è l'azienda leader nello sviluppo e nella produzione di alzacristalli e maniglie.

Il gruppo nasce da un'intensa attività di produzione per il primo equipaggiamento (Original Equipment -OE) dedicata alla realizzazione di articoli per i principali costruttori di automobili. Attualmente il core business del gruppo è soprattutto l'Aftermarket, sebbene il 25% della produzione globale rimane quella di primo equipaggiamento, dove il gruppo è universalmente apprezzato per la **qualità**, la **professionalità** e la **flessibilità** nella **progettazione** e nello **sviluppo**.

Il mantenimento di un elevato livello qualitativo ha permesso al gruppo di ottenere le **certificazioni ISO 9001:2008 e ISO/TS 16949 di primo equipaggiamento (OE)**.

La sede commerciale globale di ALGO Group si trova ad Albavilla ed è affiancata da tre stabilimenti produttivi e da un centro logistico in **Italia**, da uno stabilimento produttivo in **Polonia** e dalla sede NAFTA di **Città del Messico**.

*With **more than 40 years' experience**, the ALGO Group is the aftermarket's leader for the development and production of power windows and door handles.*

ALGO originally started off as an OE manufacturer, supplying all major car makers.

*Nowadays, although ALGO's core business is the aftermarket, the involvement with the OE production still remains in the percentage of up to 25%, which is highly appreciated for its **quality, proficiency and flexibility** in **design** and **development**.*

*As the high quality level is one of ALGO's main priorities, the company obtained the **ISO 9001:2008 and ISO/TS 16949 certifications for the OE production**.*

*ALGO's headquarters is based in Albavilla, Como, **Italy**, with three production plants also in Italy, one in **Poland** and one facility in **Mexico**.*

 LIFT TEK

 ELECTRIC-LIFE

 PMM

 MIRAGLIO

**DOPPIA FUNE GUIDATA | DOUBLE BOWDEN TYPE
MECCANISMO | MECHANICAL PART ONLY**

- 1** GUIDA
RAIL
- 2** FUNE
CABLE
- 3** PATTINO / PIASTRA DI SOLLEVAMENTO
SLIDING GLASS FIXATION PLATE
- 4** CARTELLA FISSAGGIO MOTORIDUTTORE
MOTOR FIXATION PLATE
- 5** STAFFA PORTACARRUCOLA
ROLLER BRACKET
- 6** STAFFA DI FISSAGGIO
FIXATION BRACKET
- 7** TAMBURO
DRUM
- 8** GOMITO IN PLASTICA
PLASTIC ELBOW

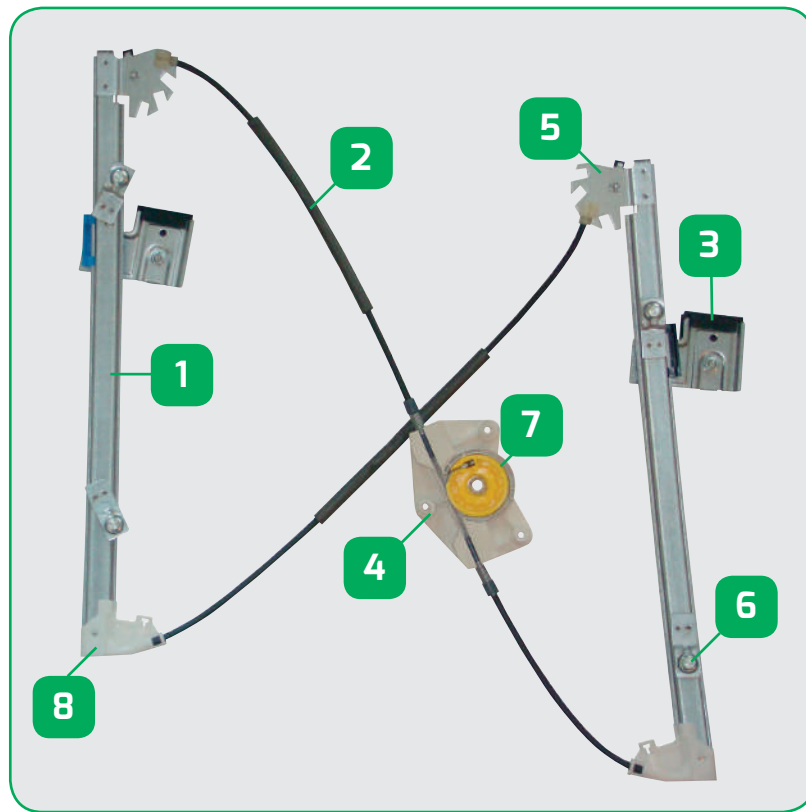

**FUNE GUIDATA | BOWDEN TYPE
ALZACRISTALLO COMPLETO | WINDOW LIFTER WITH MOTOR**

- 1** GUIDA
RAIL
- 2** FUNE
CABLE
- 3** PATTINO / PIASTRA DI SOLLEVAMENTO
SLIDING GLASS FIXATION PLATE
- 4** CARTELLA FISSAGGIO MOTORIDUTTORE
MOTOR FIXATION PLATE
- 5** STAFFA PORTACARRUCOLA
ROLLER BRACKET
- 6** STAFFA DI FISSAGGIO
FIXATION BRACKET
- 7** CONNETTORE
CONNECTOR
- 8** CENTRALINA
ELECTRONIC BOX
- 9** MOTORIDUTTORE
MOTOR
- 10** CARRUCOLA
ROLLER

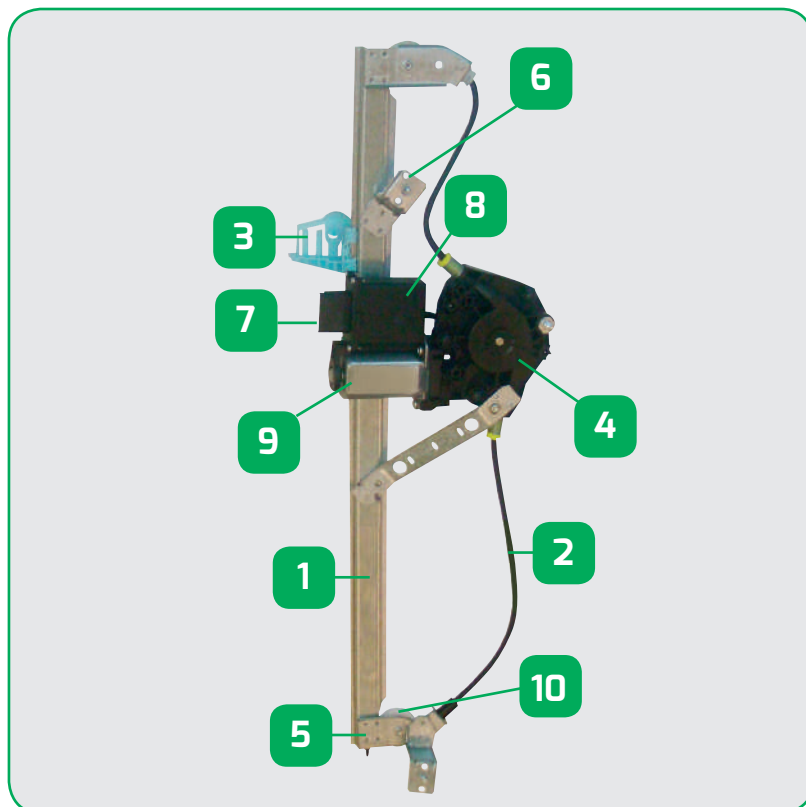

ALZACRISTALLI WINDOW REGULATORS

BRACCI INCROCIATI | *SCISSORS SYSTEM*

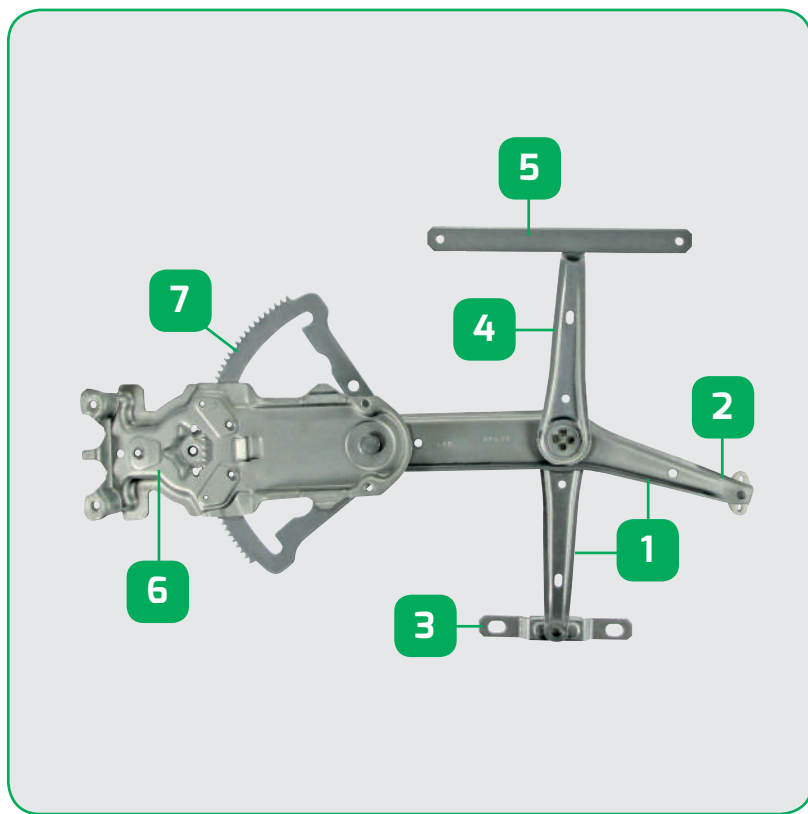

- BRACCIO SOLLEVAMENTO VETRO
GLASS LIFTING ARM **1**
- SNODO ATTACCO GUIDA VETRO
GLASS RAIL BLOCK **2**
- ATTACCO GUIDA VETRO
FIXATION BRACKET **3**
- BRACCIO DI FISSAGGIO
FIXATION ARM **4**
- GUIDA DI REGOLAZIONE
ADJUSTING RAIL **5**
- PIASTRA DI FISSAGGIO
FIXATION PLATE **6**
- CREMAGLIERA
RACK **7**

FUNE GUIDATA | *BOWDEN TYPE* ALZACRISTALLO MANUALE | *MANUAL*

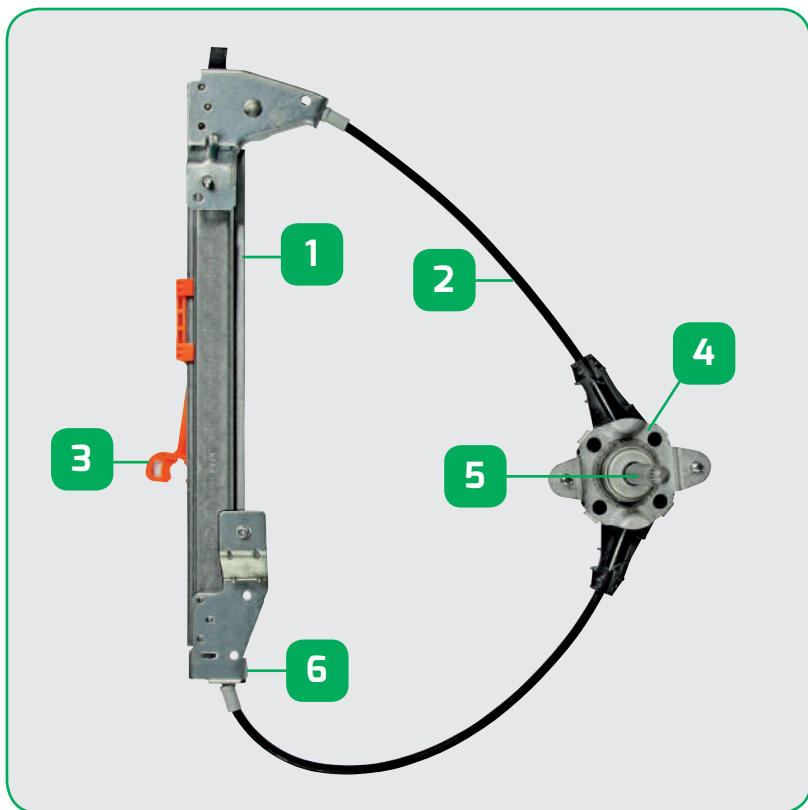

- GUIDA
RAIL **1**
- FUNE
CABLE **2**
- PATTINO / PIASTRA DI SOLLEVAMENTO
SLIDING GLASS FIXATION PLATE **3**
- CARTELLA
CENTRAL FIXATION PLATE **4**
- ALBERINO ATTACCO MANIGLIA
SHAFT **5**
- STAFFA DI FISSAGGIO
FIXATION BRACKET **6**

CAVO A SPIRALE | CABLE SYSTEM

- 1** GUIDA
RAIL
- 2** MOTORIDUTTORE
MOTOR
- 3** PATTINO / PIASTRA DI SOLLEVAMENTO
SLIDING GLASS FIXATION PLATE
- 4** GOMITO DI PLASTICA
PLASTIC ELBOW
- 5** TUBO
PLASTIC TUBE
- 6** STAFFA DI FISSAGGIO
FIXATION BRACKET

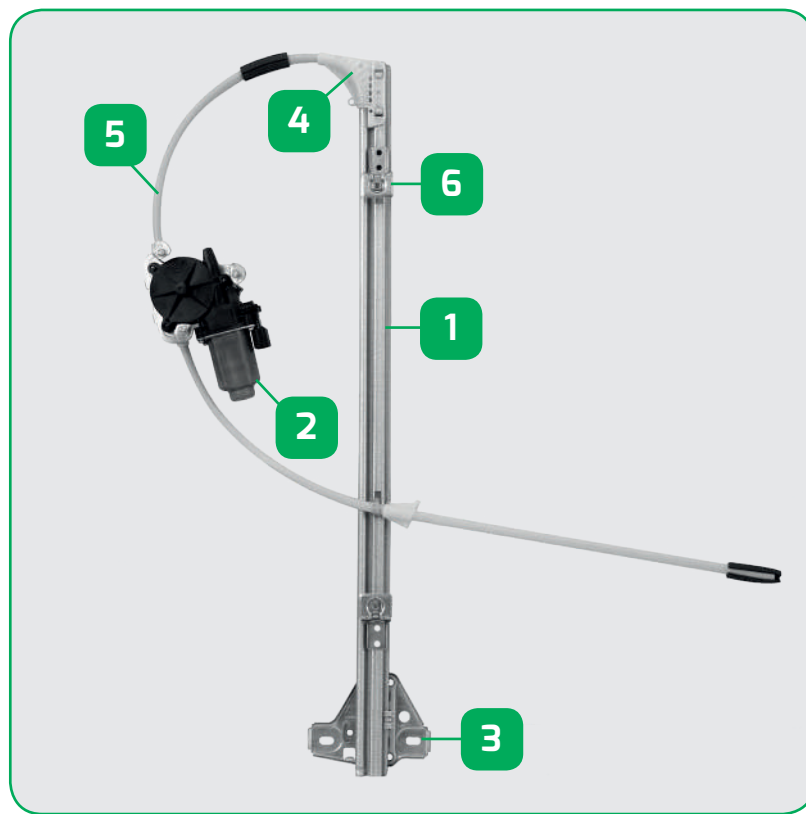

PANNELLO | PANEL

- 1** GUIDA
RAIL
- 2** FUNE
CABLE
- 3** PATTINO / PIASTRA DI SOLLEVAMENTO
SLIDING GLASS FIXATION PLATE
- 4** CARTELLA FISSAGGIO MOTORIDUTTORE
MOTOR FIXATION PLATE
- 5** CARRUCOLA
ROLLER
- 6** STAFFA DI FISSAGGIO
FIXATION BRACKET
- 7** PANNELLO
PANEL

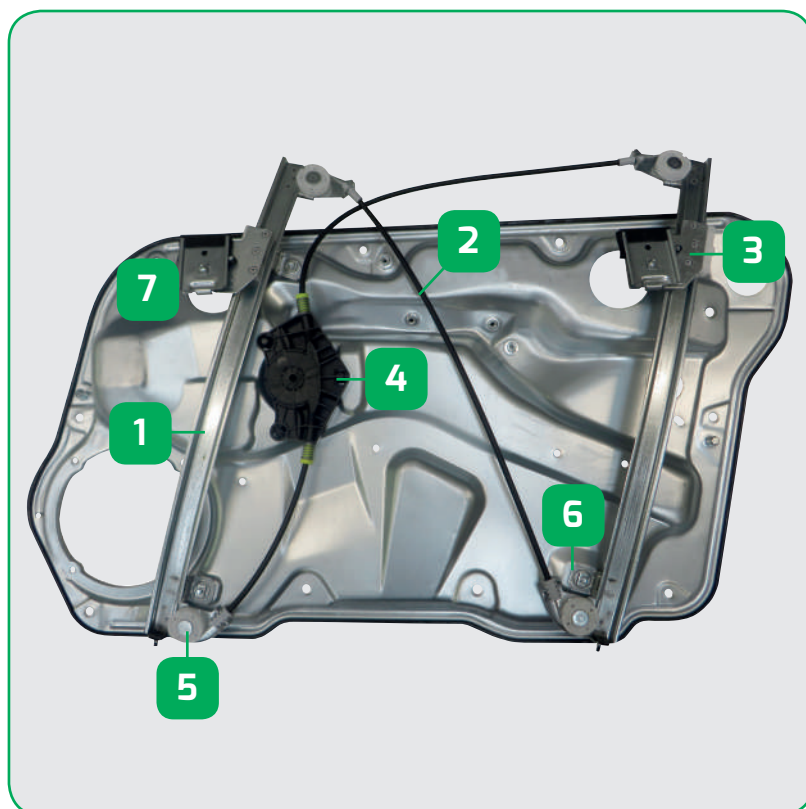

SOLO MOTORE SENZA FUNZIONE COMFORT | ONLY MOTOR WITHOUT COMFORT FUNCTION



SOLO MOTORE CON FUNZIONE COMFORT | ONLY MOTOR WITH COMFORT FUNCTION

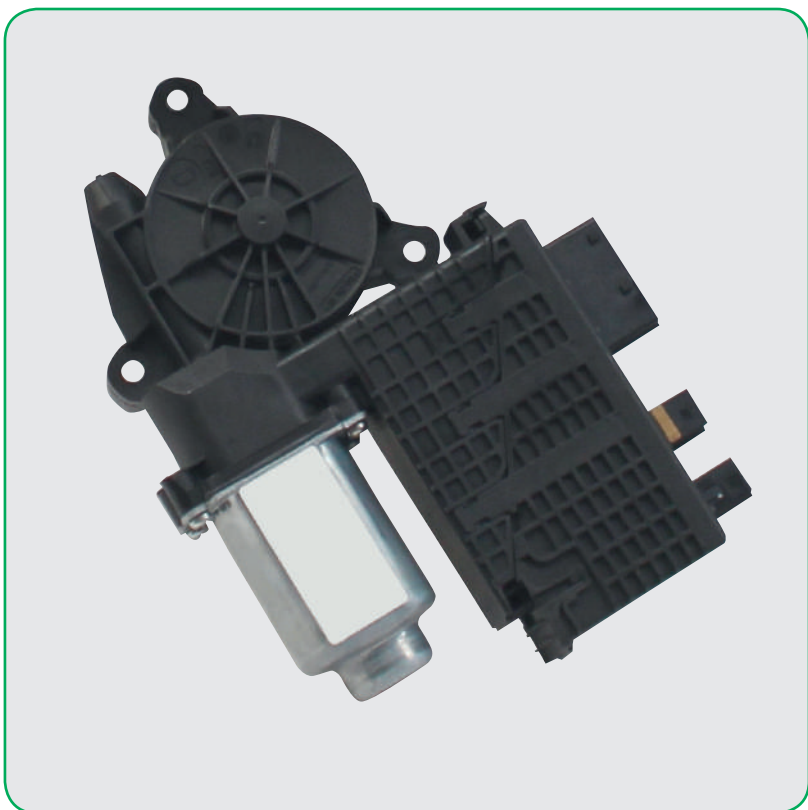

PORTE | NUMBERS OF DOORS | TÜREN | PORTES | PUERTAS



- 2 PORTE
- 2 DOORS
- 2-TÜRER
- 2 PORTES
- 2 PUERTAS



- 4 PORTE
- 4 DOORS
- 4-TÜRER
- 4 PORTES
- 4 PUERTAS



- 2 E 4 PORTE
- 2 AND 4 DOORS
- 2- UND 4-TÜRER
- 2 ET 4 PORTES
- 2 Y 4 PUERTAS

LATO SINISTRO | LEFT HAND SIDE | LINKE SEITE | COTE GAUCHE | LADO IZQUIERDO



- 2 PORTE ANTERIORI
- 2 DOORS FRONT
- 2-TÜRER VORNE
- 2 PORTES AVANT
- 2 PUERTAS DELANTERO



- 4 PORTE ANTERIORI
- 4 DOORS FRONT
- 4-TÜRER VORNE
- 4 PORTES AVANT
- 4 PUERTAS DELANTERO



- 4 PORTE POSTERIORI
- 4 DOORS REAR
- 4-TÜRER HINTEN
- 4 PORTES ARRIERE
- 4 PUERTAS TRASERO

LATO DESTRO | RIGHT HAND SIDE | RECHTE SEITE | COTE DROIT | LADO DERECHO



- 2 PORTE ANTERIORI
- 2 DOORS FRONT
- 2-TÜRER VORNE
- 2 PORTES AVANT
- 2 PUERTAS DELANTERO

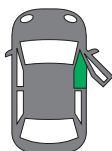

- 4 PORTE ANTERIORI
- 4 DOORS FRONT
- 4-TÜRER VORNE
- 4 PORTES AVANT
- 4 PUERTAS DELANTERO



- 4 PORTE POSTERIORI
- 4 DOORS REAR
- 4-TÜRER HINTEN
- 4 PORTES ARRIERE
- 4 PUERTAS DELANTERO



- LUNOTTO POSTERIORE
- REAR WINDOW
- HECKSCHEIBE
- LUNETTE ARRIERE
- LUNETTA TRASERA



- COMPATIBILE CON FUNZIONE COMFORT
- COMPATIBLE WITH COMFORT FUNCTION
- KOMPATIBEL MIT KOMFORT-FUNKTION
- COMPATIBLE AVEC FONCTION CONFORT
- CON FUNCION CONFORT



- SOLO MOTORE CON FUNZIONE COMFORT
- MOTOR ONLY WITH COMFORT FUNCTION
- NUR MOTOR MIT KOMFORT-FUNKTION
- MOTEUR AVEC FONCTION CONFORT UNIQUEMENT
- SOLO MOTOR CON FUNCION CONFORT



- NON COMPATIBILE CON FUNZIONE COMFORT
- NOT COMPATIBLE WITH COMFORT FUNCTION
- NICHT KOMPATIBEL MIT KOMFORT-FUNKTION
- NON COMPATIBLE AVEC FONCTION CONFORT
- SIN FUNCION CONFORT



- SOLO MOTORE SENZA FUNZIONE COMFORT
- MOTOR ONLY WITHOUT COMFORT FUNCTION
- NUR MOTOR OHNE KOMFORT-FUNKTION
- MOTEUR SANS FONCTION CONFORT UNIQUEMENT
- SOLO MOTOR SIN FUNCION CONFORT

SIMBOLI SYMBOLS



- ALZACRISTALLO MANUALE
- *MANUAL WINDOW REGULATOR*
- MANUELLER FENSTERHEBER
- LEVE-VITRE MANUEL
- ELEVACIONES MANUAL

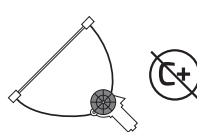

- ALZACRISTALLO CON MOTORE 2 PIN
- *ELECTRIC WINDOW REGULATOR WITHOUT COMFORT FUNCTION*
- FENSTERHEBER MIT 2 POLIGEM MOTOR
- *LEVE-VITRE AVEC MOTEUR 2 PINS*
- ELEVACIONES CON MOTOR CON 2 PINES

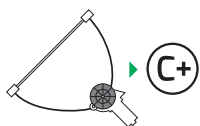

- ALZACRISTALLO CON MOTORE COMFORT
- *ELECTRIC WINDOW REGULATOR WITH COMFORT FUNCTION*
- FENSTERHEBER MIT KOMFORT-MOTOR
- *LEVE-VITRE AVEC MOTEUR COMFORT*
- ELEVACIONES CON MOTOR COMFORT

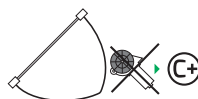

- SOLO MECCANISMO PER MOTORI CON FUNZIONE COMFORT
- *MECHANISM ONLY FOR COMFORT FUNCTION MOTOR*
- NUR MECHANISMUS FÜR MOTOR MIT KOMFORTFUNKTION
- *MECANISME POUR CONFORT MOTEUR UNIQUEMENT*
- SOLO MECANISMO PARA MOTOR COMFORT

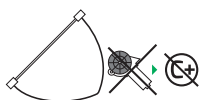

- SOLO MECCANISMO PER MOTORI 2 PIN
- *MECHANISM ONLY FOR MOTOR WITHOUT COMFORT FUNCTION*
- NUR MECHANISMUS FÜR 2 POLIGEN MOTOR
- *MECANISME POUR MOTEUR AVEC 2 PINS UNIQUEMENT*
- SOLO MECANISMO PARA MOTOR 2 PINES

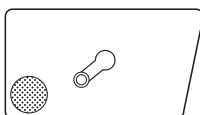

- PANNELLO CON MECCANISMO PER SISTEMA MANUALE
- *PANEL WITH MECHANISM FOR MANUAL WINDOW REGULATOR*
- RÜCKENPLATTE MIT MECHANISMUS FÜR MANUELLES SYSTEM
- *PANNEAU AVEC MECANISME POUR SYSTEME MANUEL*
- PANEL CON MECANISMO PARA SISTEMA MANUAL

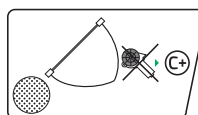

- PANNELLO CON MECCANISMO PER MOTORI CON FUNZIONE COMFORT
- *PANEL WITH MECHANISM ONLY FOR COMFORT FUNCTION MOTOR*
- RÜCKENPLATTE MIT MECHANISMUS FÜR MOTOR MIT KOMFORTFUNKTION
- *PANNEAU AVEC MECANISME POUR MOTEUR AVEC FONCTION COMFORT*
- PANEL CON MECANISMO PARA MOTOR CON FUNCION COMFORT

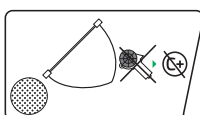

- PANNELLO CON MECCANISMO PER MOTORE 2 PIN
- *PANEL WITH MECHANISM ONLY FOR MOTOR WITHOUT COMFORT FUNCTION*
- RÜCKENPLATTE MIT MECHANISMUS FÜR 2 POLIGEN MOTOR
- *PANNEAU AVEC MECANISME POUR MOTEUR 2 PINS*
- PANEL CON MECANISMO PARA MOTOR CON 2 PINES

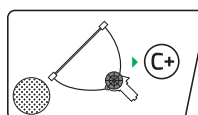

- PANNELLO CON SISTEMA COMFORT
- *PANEL WITH ELECTRIC WINDOW REGULATOR WITH COMFORT FUNCTION*
- RÜCKENPLATTE MIT KOMFORTSYSTEM
- *PANNEAU AVEC SYSTEME COMFORT*
- PANEL CON SISTEMA COMFORT

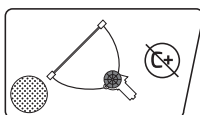

- PANNELLO CON SISTEMA 2 PIN
- *PANEL WITH ELECTRIC WINDOW REGULATOR WITHOUT COMFORT FUNCTION*
- RÜCKENPLATTE MIT 2-POL-SYSTEM
- *PANNEAU AVEC SYSTEME 2 PINS*
- PANEL CON SISTEMA 2 PINES



- INQUADRA IL QR CODE PER SCARICARE LE ISTRUZIONI DI MONTAGGIO
- *SCAN THE QR CODE TO DOWNLOAD THE FITTING INSTRUCTION*
- ZUM HERUNTERLADEN DER MONTAGEANLEITUNG QR-CODE MIT SMARTPHONE EINLESEN
- *SCANNER LE CODE QR POUR TELECHARGER LES INSTRUCTIONS DE MONTAGE*
- ESCANEAR EL CÓDIGO QR PARA DESCARGAR LAS INSTRUCCIONES DE MONTAJE



ALZACRISTALLI

WINDOW REGULATORS

FENSTERHEBER











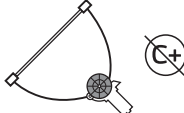



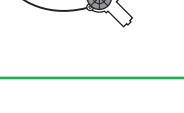

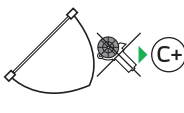





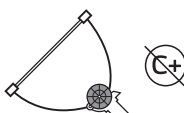









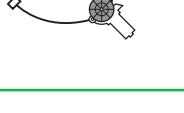

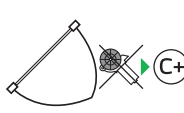



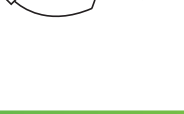

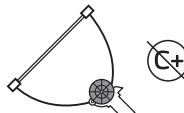
LEVE-VITRES



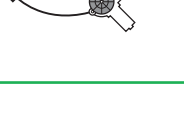

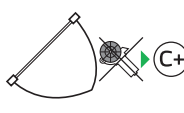
ELEVALUNAS





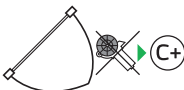





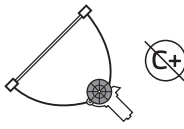



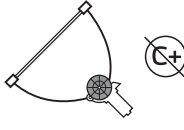



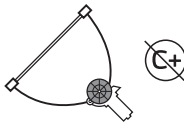



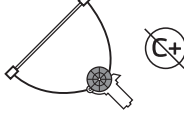



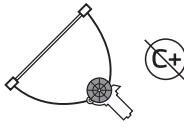



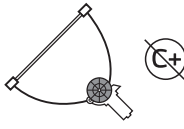





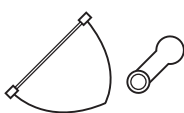



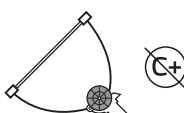



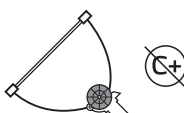



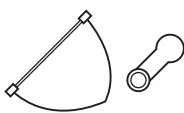



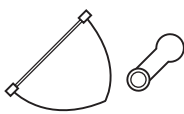



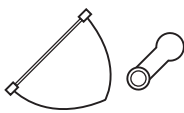



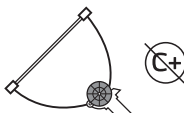







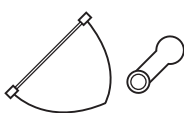





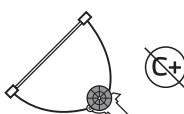







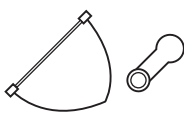





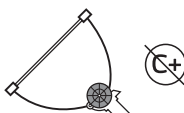







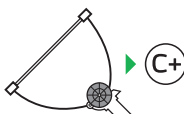





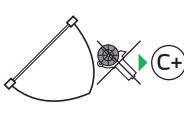

| | |
|----------------------|----|
| Daf | 3 |
| Isuzu | 5 |
| Iveco | 6 |
| Man | 14 |
| Mercedes Benz Trucks | 15 |
| Renault Trucks | 17 |
| Scania | 20 |
| Volvo Trucks | 21 |





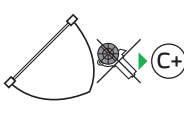





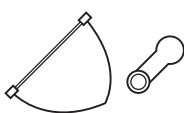



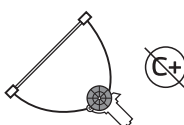



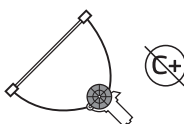



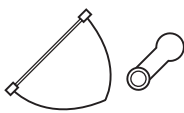

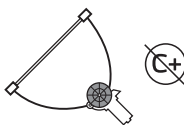

| Modello Model | Porte Doors | Ns. Rif. Our Rif | Technology | Connettore Connector | OEM | | |
|------------------|-------------------------------------------------------------------------------------|---------------------|-------------------------------------------------------------------------------------|-------------------------------------------------------------------------------------|-------------------------------------------------------------------------------------|---------------------------------------------------------------------------------------|---------------------------------------------------------------------------------------|
| CF SERIE | | | | | | | |
| 2001> |  | 30/2065 |  |  |  | 1374568 |  |
| |  | 30/2064 |  | | | | |
| 2001> |  | 30/1781 |  |  | 1918143 |  | |
| |  | 30/1780 |  | | | | |
| LF | | | | | | | |
| 2001> |  | 30/1521 |  |  | 1400753 1705698 1714809 1400755 | |  |
| |  | 30/1520 |  | | | 1400754 1705699 1714810 1400756 | |
| XF95 | | | | | | | |
| 2002>2006 |  | 30/2067 |  |  | 1354702 |  | |
| |  | 30/2066 |  | | | | 1354703 |
| 2002>2006 |  | 30/1783 |  |  | 1779721 1918145 | |  |
| |  | 30/1782 |  | | | | |
| XF105 | | | | | | | |
| 2007> |  | 30/2067 |  |  | 1354702 |  | |
| |  | 30/2066 |  | | | | 1354703 |
| 2007> |  | 30/1783 |  |  | 1779721 1918145 | |  |
| |  | 30/1782 |  | | | | |



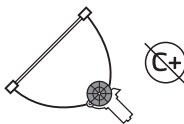



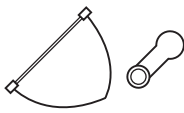



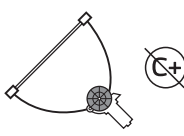



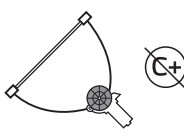



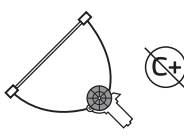



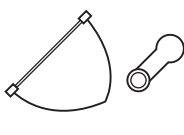



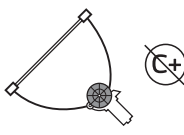



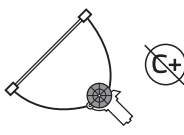



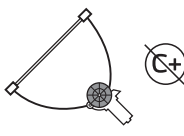



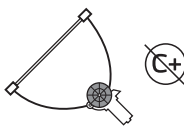

| Modello Model | Porte Doors | Ns. Rif. Our Rif | Tecnologia Technology | Connettore Connector | OEM | |
|------------------|-----------------------------------------------------------------------------------|---------------------|-----------------------------------------------------------------------------------|-----------------------------------------------------------------------------------|---------|-------------------------------------------------------------------------------------|
| XF106 | | | | | | |
| 2013> |  | 30/2608 |  |  | |  |
| |  | 30/2607 | | | | |
| | | | | | 1881915 | |

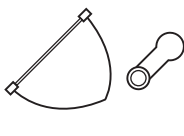



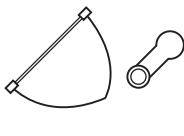





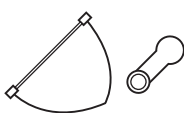



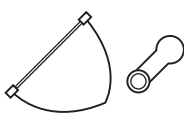



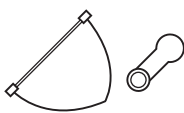



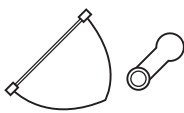



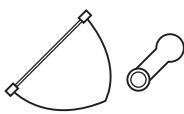

| Modello Model | Porte Doors | Ns. Rif. Our Rif | Tecnologia Technology | Connettore Connector | OEM | |
|------------------|-------------------------------------------------------------------------------------|---------------------|-------------------------------------------------------------------------------------|-------------------------------------------------------------------------------------|---------------------------------------------------------------------------------------|---------------------------------------------------------------------------------------|
| Amigo | | | | | | |
| 1991> |  | 30/7135 |  |  |  |  |
| | | 30/7136 | | | | |
| 1998> |  | 30/7137 |  |  |  |  |
| | | 30/7138 | | | | |
| F series | | | | | | |
| 1998> |  | 30/7137 |  |  |  |  |
| | | 30/7138 | | | | |
| N series | | | | | | |
| 1998> |  | 30/7137 |  |  |  |  |
| | | 30/7138 | | | | |
| NPR / NKR | | | | | | |
| 1998>2008 |  | 30/2329 |  |  |  |  |
| | | 30/2328 | | | | |
| NQR | | | | | | |
| 1998>2008 |  | 30/2329 |  |  |  |  |
| | | 30/2328 | | | | |

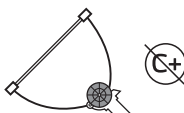



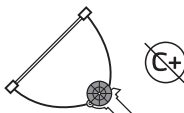







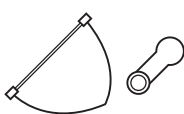



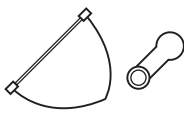



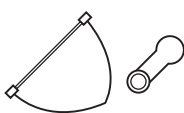



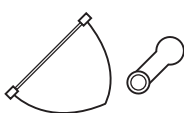

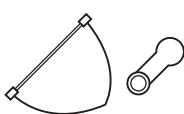

| Modello Model | Porte Doors | Ns. Rif. Our Rif | Tecnologia Technology | Connettore Connector | OEM | |
|------------------|-------------------------------------------------------------------------------------|---------------------|-------------------------------------------------------------------------------------|-------------------------------------------------------------------------------------|---------------------------------------------------------------------------------------|---------------------------------------------------------------------------------------|
| ASTRA HD7 | | | | | | |
| 1996>2001 |  | 30/237B |  |  | |  |
| | | 30/237 | | | | |
| 1996>2001 |  | 30/7139 |  |  |  |  |
| | | 30/7140 | | | | |
| ASTRA HD8 | | | | | | |
| 2005> |  | 30/7141 |  |  |  |  |
| | | 30/7142 | | | | |
| DAILY I | | | | | | |
| 1978>1989 |  | 30/139B |  |  | |  |
| | | 30/139 | | | | |
| 1978>1989 |  | 30/146B |  |  | |  |
| | | 30/146 | | | | |
| DAILY II | | | | | | |
| 1989>1999 |  | 30/179B |  |  | |  |
| | | 30/179 | | | | |
| 1989>1999 |  | 30/752 |  |  |  |  |
| | | 30/751 | | | | |



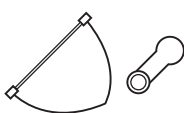



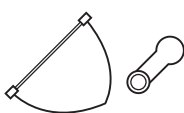



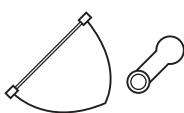



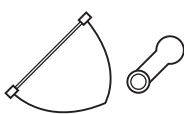



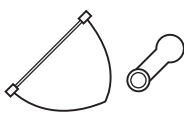



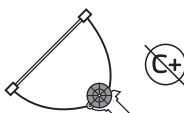



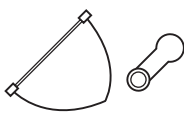

| Modello Model | Porte Doors | Ns. Rif. Our Rif | Tecnologia Technology | Connettore Connector | OEM | | |
|--------------------------|-------------------------------------------------------------------------------------|-------------------------------------------------------------------------------------|--------------------------|-------------------------------------------------------------------------------------|---------------------------------------------------------------------------------------|------------------------------------------------|---------------------------------------------------------------------------------------|
| DAILY III - S2000 | | | | | | | |
| 1999>2006 |  |  | 30/208B |  |  | 500314249 504205269 5802133034 |  |
| |  |  | 30/208 | | | 500314250 504205271 5802133035 | |
| 1999>2006 |  |  | 30/1006 |  |  | 500314229 504053527 504173868 9160792 |  |
| |  |  | 30/1005 | |  | 500314230 504053528 504173866 9160793 | |
| DAILY IV - V | | | | | | | |
| 2006>2014 |  |  | 30/208B |  |  | 500314249 504205269 5802133034 |  |
| |  |  | 30/208 | | | 500314250 504205271 5802133035 | |
| 2006>2014 |  |  | 30/1006 |  |  | 504053527 504173868 9160792 |  |
| |  |  | 30/1005 | |  | 504053528 504173866 9160793 | |
| 2006>2014 |  |  | 30/1006C |  |  | 504335520 42574132 |  |
| |  |  | 30/1005C | |  | 504335517 42574133 | |
| 2006>2014 |  |  | 30/1671 |  |  | 42565949 504356352 504335515 |  |
| |  |  | 30/1670 | | | 42565948 504356351 504335512 | |
| 2006>2014 |  |  | 30/1793 |  |  | 5801482033 |  |
| |  |  | 30/1792 | | | 5801482026 | |

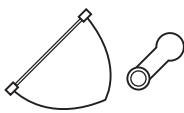



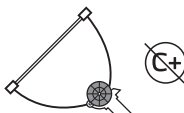





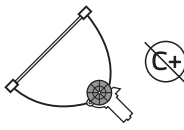





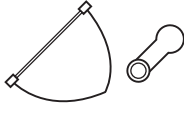



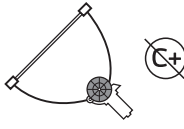





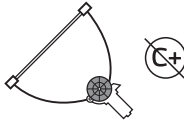



| Modello Model | Porte Doors | Ns. Rif. Our Rif | Tecnologia Technology | Connettore Connector | OEM | |
|------------------|-------------------------------------------------------------------------------------|---------------------|-------------------------------------------------------------------------------------|-------------------------------------------------------------------------------------|---------------------------------------------------------------------------------------|---------------------------------------------------------------------------------------|
| EuroCargo | | | | | | |
| 1991>2002 |  | 30/186B |  |  | |  |
| | | 30/186 | | | | |
| 1991>2002 |  | 30/1567 |  |  |  |  |
| | | 30/1566 | | | | |
| 1991>2002 |  | 30/749 |  |  |  |  |
| | | 30/748 | | | | |
| EuroStar | | | | | | |
| 1992>2002 |  | 30/186B |  |  | |  |
| | | 30/186 | | | | |
| 1992>2002 |  | 30/1567 |  |  |  |  |
| | | 30/1566 | | | | |
| 1992>2002 |  | 30/749 |  |  |  |  |
| | | 30/748 | | | | |
| EuroTech | | | | | | |
| 1991>2002 |  | 30/186B |  |  | |  |
| | | 30/186 | | | | |

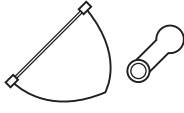



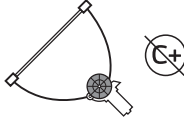





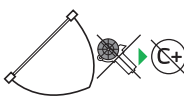



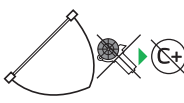



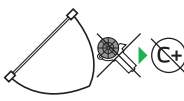

| Modello Model | Porte Doors | Ns. Rif. Our RIF | Tecnologia Technology | Connettore Connector | OEM | |
|------------------|-------------------------------------------------------------------------------------|---------------------|-------------------------------------------------------------------------------------|-------------------------------------------------------------------------------------|---------------------------------------------------------------------------------------|---------------------------------------------------------------------------------------|
| EuroTech | | | | | | |
| 1991>2002 |  | 30/1567 |  |  |  |  |
| | | 30/1566 | | | | |
| 1991>2002 |  | 30/1566 |  |  |  |  |
| | | 30/748 | | | | |
| 1991>2002 |  | 30/749 |  |  |  |  |
| | | 30/748 | | | | |
| 1993>2004 |  | 30/186B |  |  |  |  |
| | | 30/186 | | | | |
| 1993>2004 |  | 30/186 |  |  |  |  |
| | | 30/1567 | | | | |
| 1993>2004 |  | 30/1567 |  |  |  |  |
| | | 30/1566 | | | | |
| 1993>2004 |  | 30/749 |  |  |  |  |
| | | 30/748 | | | | |
| 1993>2004 |  | 30/749 |  |  |  |  |
| | | 30/748 | | | | |
| GRINTA | | | | | | |
| 1975>1978 |  | 30/138 |  |  |  |  |
| | | 30/138 | | | | |
| 1975>1978 |  | 30/138 |  |  |  |  |
| | | 30/138 | | | | |

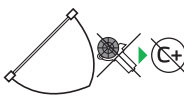



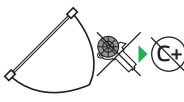





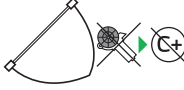



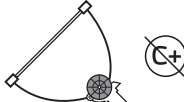



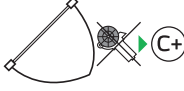



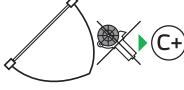

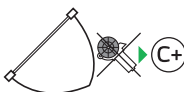

| Modello Model | Porte Doors | Ns. Rif. Our Rif | Tecnologia Technology | Connettore Connector | OEM | |
|------------------|-------------------------------------------------------------------------------------|---------------------|-------------------------------------------------------------------------------------|-------------------------------------------------------------------------------------|---------------------------------|---------------------------------------------------------------------------------------|
| GRINTA | | | | | | |
| 1978>1981 |  | 30/139B |  |  | |  |
| | | 30/139 | | | | |
| |  | 30/139 | | | 93902694 | |
| 1981>1989 |  | 30/146B |  |  | |  |
| | | 30/146 | | | | |
| |  | 30/146 | | | 93908381 2997182 | |
| 1989> |  | 30/179B |  |  | |  |
| | | 30/179 | | | | |
| |  | 30/179 | | | 93941270 | |
| LEONCINO | | | | | | |
| |  | 30/33B |  |  | |  |
| | | 30/34B | | | | |
| |  | 30/34B | | | 9050667 | |
| Magirus | | | | | | |
| 1991> |  | 30/186B |  |  | |  |
| | | 30/186 | | | | |
| |  | 30/186 | | | 98407741 98407743 | |
| 1991> |  | 30/1567 |  |  | |  |
| | | 30/1566 | | | | |
| |  | 30/1566 | | | 98407721 99487780 2997195 | |
| 1991> |  | 30/749 |  |  | |  |
| | | 30/748 | | | | |
| |  | 30/748 | | | 98407721 99487780 2997195 | |

| Modello Model | Porte Doors | Ns. Rif. Our Rif | Tecnologia Technology | Connettore Connector | OEM | |
|-------------------------------------------------------------------------------------|-------------------------------------------------------------------------------------|---------------------|-------------------------------------------------------------------------------------|-------------------------------------------------------------------------------------|---------|---------------------------------------------------------------------------------------|
| OM 100 NC | | | | | | |
|  |  | 30/70 |  |  | 4644623 |  |
| | | 30/69 | | | 4644622 | |
| OM 110 | | | | | | |
|  |  | 30/70 |  |  | 4644623 |  |
| | | 30/69 | | | 4644622 | |
| OM 190 NC | | | | | | |
|  |  | 30/70 |  |  | 4644623 |  |
| | | 30/69 | | | 4644622 | |
| OM 300 | | | | | | |
|  |  | 30/70 |  |  | 4644623 |  |
| | | 30/69 | | | 4644622 | |
| OM 619 | | | | | | |
|  |  | 30/70 |  |  | 4644623 |  |
| | | 30/69 | | | 4644622 | |
| OM 684 | | | | | | |
|  |  | 30/70 |  |  | 4644623 |  |
| | | 30/69 | | | 4644622 | |
| OM 691 | | | | | | |
|  |  | 30/70 |  |  | 4644623 |  |
| | | 30/69 | | | 4644622 | |

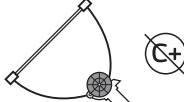
| Modello Model | Porte Doors | Ns. Rif. Our Rif | Tecnologia Technology | Connettore Connector | OEM | |
|------------------|-------------------------------------------------------------------------------------|-------------------------------------------------------------------------------------|-------------------------------------------------------------------------------------|-------------------------------------------------------------------------------------|---------------------------------|---------------------------------------------------------------------------------------|
| OM 697 | | | | | | |
| |  | 30/70 |  |  | 4644623 |  |
| |  | 30/69 | | | 4644622 | |
| S SERIE | | | | | | |
| 1981>1989 |  | 30/146B |  |  | 93908382 2997181 |  |
| | |  | | | 30/146 | |
| 1989> |  | 30/179B |  |  | 93941271 |  |
| | |  | | | 30/179 | |
| 1989> |  | 30/752 |  |  | 4856064 99485358 |  |
| | |  | | | 30/751 | |
| SERIE Z | | | | | | |
| |  | 30/90 |  |  | 9052882 |  |
| |  | 30/89 | | | 9052881 | |
| STRALIS | | | | | | |
| 2002>2013 |  | 30/186B |  |  | 98407740 98407744 |  |
| | |  | | | 30/186 | |
| 2002>2013 |  | 30/1567 |  |  | 98407722 99487781 2997196 |  |
| | |  | | | 30/1566 | |

| Modello Model | Porte Doors | Ns. Rif. Our Rif | Tecnologia Technology | Connettore Connector | OEM | |
|------------------|-------------------------------------------------------------------------------------|---------------------|-------------------------------------------------------------------------------------|-------------------------------------------------------------------------------------|---------------------------------------------------------------------------------------|---------------------------------------------------------------------------------------|
| STRALIS | | | | | | |
| 2002>2013 |  | 30/749 |  |  |  |  |
| | | 30/748 | | | | |
| |  | 30/748 | | | 98407721 99487780 2997195 | |
| TIGROTTO | | | | | | |
| |  | 30/33B |  |  | 9050668 |  |
| | | 30/34B | | | | |
| |  | 30/34B | | | | |
| Trakker | | | | | | |
| 2004> |  | 30/1567 |  |  |  |  |
| | | 30/1566 | | | | |
| |  | 30/1566 | | | 98407721 99487780 2997195 | |
| 2004> |  | 30/749 |  |  |  |  |
| | | 30/748 | | | | |
| |  | 30/748 | | | 98407721 99487780 2997195 | |
| TurboStar | | | | | | |
| 1988> |  | 30/185B |  |  | 4817019 |  |
| | | 30/185 | | | | |
| |  | 30/185 | | | | |
| 1988> |  | 30/747 |  |  |  |  |
| | | 30/746 | | | | |
| |  | 30/746 | | | 4817201 | |

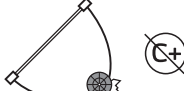



| Modello Model | Porte Doors | Ns. Rif. Our Rif | Tecnologia Technology | Connettore Connector | OEM | |
|------------------|-------------------------------------------------------------------------------------|---------------------|-------------------------------------------------------------------------------------|-------------------------------------------------------------------------------------|-------------|---------------------------------------------------------------------------------------|
| TGA | | | | | | |
| 2000>2007 |  | 30/2075 |  |  | 81626456053 |  |
| |  | 30/2074 | | | 81626456052 | |
| TGL | | | | | | |
| 2000> |  | 30/2075 |  |  | 81626456053 |  |
| |  | 30/2074 | | | 81626456052 | |
| TGM | | | | | | |
| 2000> |  | 30/2075 |  |  | 81626456053 |  |
| |  | 30/2074 | | | 81626456052 | |
| TGS | | | | | | |
| 2007> |  | 30/1779 |  |  | 81626456055 |  |
| |  | 30/1778 | | | 81626456054 | |
| TGX | | | | | | |
| 2007> |  | 30/1779 |  |  | 81626456055 |  |
| |  | 30/1778 | | | 81626456054 | |

| Modello Model | Porte Doors | Ns. Rif. Our RIF | Tecnologia Technology | Connettore Connector | OEM | |
|-------------------|-------------------------------------------------------------------------------------|---------------------|-------------------------------------------------------------------------------------|-------------------------------------------------------------------------------------|----------------------------|---------------------------------------------------------------------------------------|
| Actros MP1 | | | | | | |
| 1996>2003 |  | 30/2616 |  |  | A0007250002 A0007200079 |  |
| | | 30/2615 | | | | |
| 1996>2003 |  | 30/1777 |  |  | A0007250002 A0007200079 |  |
| | | 30/1776 | | | | |
| Actros MP2 | | | | | | |
| 2003>2008 |  | 30/2177 |  |  | 9607201346 |  |
| | | 30/2176 | | | 9607201446 | |
| 2008>2012 |  | 30/2177 |  |  | 9607201346 |  |
| | | 30/2176 | | | 9607201446 | |
| Actros MP4 | | | | | | |
| 2012> |  | 30/2189 |  |  | A9607201746 |  |
| | | 30/2188 | | | A9607201646 | |
| Arocs | | | | | | |
| 1998>2011 |  | 30/1773 |  |  | A9737200346 |  |
| | | 30/1772 | | | A9737200446 | |
| ATEGO | | | | | | |
| 1998>2003 |  | 30/1773 |  |  | A9737200346 |  |
| | | 30/1772 | | | A9737200446 | |



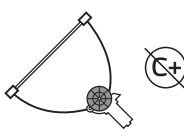







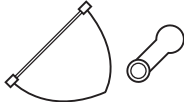



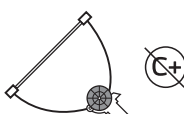



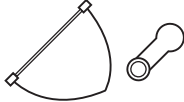



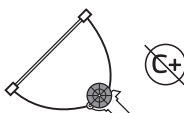





Mercedes Benz Trucks

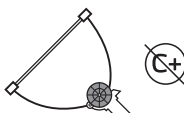



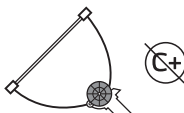





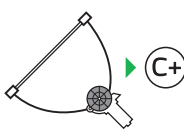





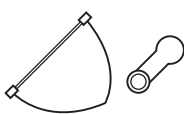



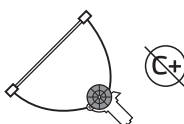





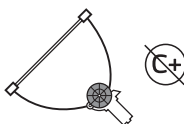





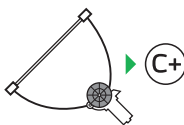



Alzacristalli | Window regulators

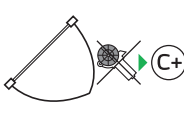



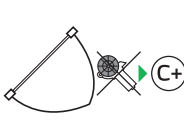





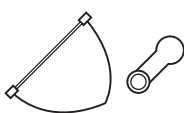



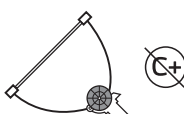



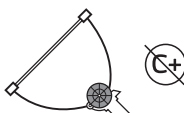





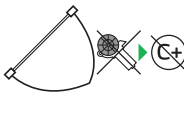





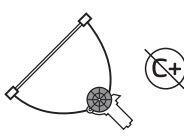



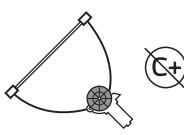

| Modello Model | Porte Doors | Ns. Rif. Our Rif | Tecnologia Technology | Connettore Connector | OEM | |
|-------------------|-----------------------------------------------------------------------------------|---------------------|-----------------------------------------------------------------------------------|-----------------------------------------------------------------------------------|-------------------------------------------------------------------------------------|-------------|
| AXOR 98-03 | | | | | | |
| 1998>2003 |  | 30/1773 |  |  |  | A9737200346 |
| |  | 30/1772 | | | | A9737200446 |





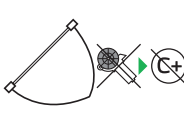





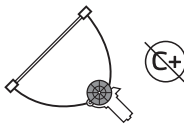





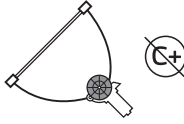





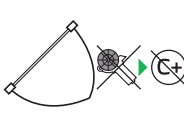





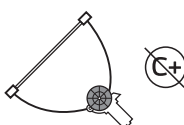





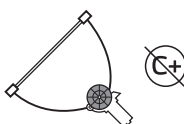

| Modello Model | Porte Doors | Ns. Rif. Our Rif | Tecnologia Technology | Connettore Connector | OEM | |
|---------------------------|-------------------------------------------------------------------------------------|---------------------|-------------------------------------------------------------------------------------|-------------------------------------------------------------------------------------|---------------------------------------------------------------------------------------|---------------------------------------------------------------------------------------|
| C series 250-320CV | | | | | | |
| 2013> |  | 30/247B |  |  | |  |
| | | 30/247 | | | | |
| 2013> |  | 30/1521 |  |  |  |  |
| | | 30/1520 | | | | |
| 2013> |  | 30/247B |  |  | |  |
| | | 30/247 | | | | |
| 2013> |  | 30/1521 |  |  |  |  |
| | | 30/1520 | | | | |
| Kerax | | | | | | |
| >2012 |  | 30/247B |  |  | |  |
| | | 30/247 | | | | |
| >2012 |  | 30/1521 |  |  |  |  |
| | | 30/1520 | | | | |
| 2000>2012 |  | 30/1760 |  |  |  |  |
| | | 30/1760 | | | | |

| Modello Model | Porte Doors | Ns. Rif. Our Rif | Tecnologia Technology | | Connettore Connector | OEM | |
|------------------|-------------------------------------------------------------------------------------|---------------------|-------------------------------------------------------------------------------------|-------------------------------------------------------------------------------------|---------------------------------------------------------------------------------------|--------------------------|---------------------------------------------------------------------------------------|
| Magnum | | | | | | | |
| 2000>2012 |  | 30/1761 |  |  |  | 7482059716 |  |
| |  | 30/1761 | | | | 7482059716 | |
| Mascott | | | | | | | |
| 1998>2012 |  | 30/208B |  |  | | 7700351293 |  |
| |  | 30/208 | | | | 7700351294 | |
| 1998>2012 |  | 30/1006 |  |  |  | 7700352494 8200162708 |  |
| |  | 30/1005 | | | | 7700352495 8200162710 | |
| 1998>2012 |  | 30/1006 |  |  |  | 7700352494 8200162708 |  |
| |  | 30/1005 | | | | 7700352495 8200162710 | |
| 1998>2012 |  | 30/1006C |  |  |  | 8200467971 |  |
| |  | 30/1005C | | | | 8200467967 | |
| 1998>2012 |  | 30/1671 |  |  | | 8200467971 |  |
| |  | 30/1670 | | | | 8200467967 | |
| Maxity | | | | | | | |
| 2007> |  | 30/1817 |  |  | | 807010T000 |  |
| |  | 30/1816 | | | | 807000T000 | |

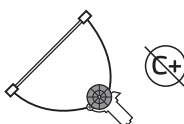
| Modello Model | Porte Doors | Ns. Rif. Our Rif | Tecnologia Technology | Connettore Connector | OEM | |
|------------------|-------------------------------------------------------------------------------------|---------------------|-------------------------------------------------------------------------------------|-------------------------------------------------------------------------------------|---------------------------------------------------------------------------------------|---------------------------------------------------------------------------------------|
| Midlum | | | | | | |
| 2000> |  | 30/247B |  |  | |  |
| | | 30/247 | | | | |
| 2000> |  | 30/1521 |  |  |  |  |
| | | 30/1520 | | | | |
| 1996>2013 |  | 30/1521 |  |  |  |  |
| | | 30/247 | | | | |
| 1996>2013 |  | 30/1520 | | | | |
| | | 30/2624 | | | | |
| 2015> |  | 30/2623 |  |  | |  |
| | | 30/2624 | | | 7482540378 | |
| | | | | | 7482540380 | |

| Modello Model | Porte Doors | Ns. Rif. Our Rif | Tecnologia Technology | | Connettore Connector | OEM | |
|------------------|-----------------------------------------------------------------------------------|---------------------|-----------------------------------------------------------------------------------|-----------------------------------------------------------------------------------|-------------------------------------------------------------------------------------|------------------------------------------|-------------------------------------------------------------------------------------|
| 3 SERIES | | | | | | | |
| 1987>1996 |  | 30/1775 |  |  |  | 1406613 |  |
| |  | 30/1774 | | | | 1406614 | |
| 4 SERIES | | | | | | | |
| 1996>2007 |  | 30/2117 |  |  |  | 1366849 1442294 2303349 2303350 |  |
| |  | 30/2116 | | | | 1366850 1442295 2303352 2303355 | |
| 1996>2007 |  | 30/1735 |  |  |  | 1366849 1442294 2303349 |  |
| |  | 30/1734 | | | | 1366850 1442295 2303352 | |

| Modello Model | Porte Doors | Ns. Rif. Our Rif | Tecnologia Technology | | Connettore Connector | OEM | |
|-------------------|-------------------------------------------------------------------------------------|-------------------------------------------------------------------------------------|-------------------------------------------------------------------------------------|-------------------------------------------------------------------------------------|---------------------------------------------------------------------------------------|----------------------|---------------------------------------------------------------------------------------|
| FE | | | | | | | |
| |  | 30/1521 |  |  |  | 20557552 82497193 |  |
| |  | 30/1520 | | | | 20557554 82497194 | |
| FH I | | | | | | | |
| 1993>2013 |  | 30/2119 |  |  |  | 3176541 |  |
| | |  | | | | 30/2118 | |
| FH4 | | | | | | | |
| 2016> |  | 30/2660 |  |  |  | 84225944 |  |
| | |  | | | | 30/2659 | |
| FL II | | | | | | | |
| 2006> |  | 30/1521 |  |  |  | 20557552 82497193 |  |
| | |  | | | | 30/1520 | |
| FM | | | | | | | |
| 2005>2013 |  | 30/2119 |  |  |  | 3176541 |  |
| | |  | | | | 30/2118 | |
| FMX series | | | | | | | |
| 2005>2013 |  | 30/2119 |  |  |  | 3176541 |  |
| | |  | | | | 30/2118 | |



MIRAGLIO

GUIDA RAPIDA

QUICK LIST



GUIDA RAPIDA / QUICK LIST

Alzacristalli | Window regulators



| Ns. rif. Our ref. | Pagina Page | Ns. rif. Our ref. | Pagina Page | Ns. rif. Our ref. | Pagina Page |
|----------------------|------------------|----------------------|----------------|----------------------|----------------|
| 30/33B | 10, 13 | 30/1782 | 3, 4 | | |
| 30/34B | 10, 13 | 30/1783 | 3, 4 | | |
| 30/69 | 11, 12 | 30/1792 | 7 | | |
| 30/70 | 11, 12 | 30/1793 | 7 | | |
| 30/89 | 12 | 30/1816 | 18 | | |
| 30/90 | 12 | 30/1817 | 18 | | |
| 30/138 | 9 | 30/2064 | 3 | | |
| 30/139 | 6, 10 | 30/2065 | 3 | | |
| 30/139B | 6, 10 | 30/2066 | 3, 4 | | |
| 30/146 | 6, 10, 12 | 30/2067 | 3, 4 | | |
| 30/146B | 6, 10, 12 | 30/2074 | 14 | | |
| 30/179 | 6, 10, 12 | 30/2075 | 14 | | |
| 30/179B | 6, 10, 12 | 30/2116 | 20 | | |
| 30/185 | 13 | 30/2117 | 20 | | |
| 30/185B | 13 | 30/2118 | 21 | | |
| 30/186 | 8, 9, 10, 12 | 30/2119 | 21 | | |
| 30/186B | 8, 9, 10, 12 | 30/2176 | 15 | | |
| 30/208 | 7, 18 | 30/2177 | 15 | | |
| 30/208B | 7, 18 | 30/2188 | 15 | | |
| 30/237 | 6 | 30/2189 | 15 | | |
| 30/237B | 6 | 30/2328 | 5 | | |
| 30/247 | 17, 19 | 30/2329 | 5 | | |
| 30/247B | 17, 19 | 30/2607 | 3 | | |
| 30/746 | 13 | 30/2608 | 3 | | |
| 30/747 | 13 | 30/2615 | 15 | | |
| 30/748 | 8, 9, 10, 13 | 30/2616 | 15 | | |
| 30/749 | 8, 9, 10, 13 | 30/2623 | 19 | | |
| 30/751 | 6, 12 | 30/2624 | 19 | | |
| 30/752 | 6, 12 | 30/2659 | 21 | | |
| 30/1005 | 7, 18 | 30/2660 | 21 | | |
| 30/1005C | 7, 18 | 30/7135 | 5 | | |
| 30/1006 | 7, 18 | 30/7136 | 5 | | |
| 30/1006C | 7, 18 | 30/7137 | 5 | | |
| 30/1520 | 3, 17, 19, 21 | 30/7138 | 5 | | |
| 30/1521 | 3, 17, 19, 21 | 30/7139 | 6 | | |
| 30/1566 | 8, 9, 10, 12, 13 | 30/7140 | 6 | | |
| 30/1567 | 8, 9, 10, 12, 13 | 30/7141 | 6 | | |
| 30/1670 | 7, 18 | 30/7142 | 6 | | |
| 30/1671 | 7, 18 | | | | |
| 30/1734 | 20 | | | | |
| 30/1735 | 20 | | | | |
| 30/1760 | 17 | | | | |
| 30/1761 | 18 | | | | |
| 30/1772 | 15, 16 | | | | |
| 30/1773 | 15, 16 | | | | |
| 30/1774 | 20 | | | | |
| 30/1775 | 20 | | | | |
| 30/1776 | 15 | | | | |
| 30/1777 | 15 | | | | |
| 30/1778 | 14 | | | | |
| 30/1779 | 14 | | | | |
| 30/1780 | 3 | | | | |
| 30/1781 | 3 | | | | |



MIRAGLIO

TAVOLE DI COMPARAZIONE
CROSS REFERENCE GUIDE



TAVOLE DI COMPARAZIONE / CROSS REFERENCE GUIDE

Alzacristalli / Window regulators



| Rif. adattabilità Compatible OEM ref. | Ns. rif. Our ref. | Rif. adattabilità Compatible OEM ref. | Ns. rif. Our ref. | Rif. adattabilità Compatible OEM ref. | Ns. rif. Our ref. |
|------------------------------------------|----------------------|------------------------------------------|----------------------|------------------------------------------|----------------------|
| 1354702 | 30/2067 | 4817202 | 30/747 | 8970935310 | 30/7136 |
| 1354703 | 30/2066 | 4856063 | 30/751 | 8970935320 | 30/7135 |
| 1366849 | 30/2117 | 4856064 | 30/752 | 8971658810 | 30/7136 |
| 1366849 | 30/1735 | 500314229 | 30/1006 | 8971658820 | 30/7135 |
| 1366850 | 30/2116 | 500314230 | 30/1005 | 8978681132 | 30/2328 |
| 1366850 | 30/1734 | 500314249 | 30/208B | 8978681142 | 30/2329 |
| 1374568 | 30/2065 | 500314250 | 30/208 | 9050667 | 30/348 |
| 1374569 | 30/2064 | 500411309 | 30/7141 | 9050668 | 30/338 |
| 1400753 | 30/1521 | 500411310 | 30/7142 | 9052881 | 30/89 |
| 1400754 | 30/1520 | 5010301991 | 30/247B | 9052882 | 30/90 |
| 1400755 | 30/1521 | 5010301992 | 30/247 | 9160792 | 30/1006 |
| 1400756 | 30/1520 | 5010301993 | 30/1521 | 9160793 | 30/1005 |
| 1406613 | 30/1775 | 5010301994 | 30/1520 | 93901001 | 30/138 |
| 1406614 | 30/1774 | 5010468940 | 30/1760 | 93902694 | 30/139 |
| 1442294 | 30/2117 | 504053527 | 30/1006 | 93902695 | 30/139B |
| 1442294 | 30/1735 | 504053528 | 30/1005 | 93908381 | 30/146 |
| 1442295 | 30/2116 | 504173866 | 30/1005 | 93908382 | 30/146B |
| 1442295 | 30/1734 | 504173868 | 30/1006 | 93926734 | 30/179 |
| 1705698 | 30/1521 | 504205269 | 30/208B | 93926735 | 30/179B |
| 1705699 | 30/1520 | 504205271 | 30/208 | 93941270 | 30/179 |
| 1714809 | 30/1521 | 504335512 | 30/1670 | 93941271 | 30/179B |
| 1714810 | 30/1520 | 504335515 | 30/1671 | 9607201346 | 30/2177 |
| 1779721 | 30/1783 | 504335517 | 30/1005C | 9607201446 | 30/2176 |
| 1779722 | 30/1782 | 504335520 | 30/1006C | 98171178 | 30/237 |
| 1881914 | 30/2608 | 504356351 | 30/1670 | 98171179 | 30/237B |
| 1881915 | 30/2607 | 504356352 | 30/1671 | 98171181 | 30/7140 |
| 1918143 | 30/1781 | 5801482026 | 30/1792 | 98171182 | 30/7139 |
| 1918144 | 30/1780 | 5801482033 | 30/1793 | 98407721 | 30/1566 |
| 1918145 | 30/1783 | 5802133034 | 30/208B | 98407721 | 30/748 |
| 1918146 | 30/1782 | 5802133035 | 30/208 | 98407722 | 30/1567 |
| 20557552 | 30/1521 | 7482059716 | 30/1761 | 98407722 | 30/749 |
| 20557554 | 30/1520 | 7482497191 | 30/247B | 98407740 | 30/186B |
| 2303349 | 30/2117 | 7482497192 | 30/247 | 98407741 | 30/186 |
| 2303349 | 30/1735 | 7482497193 | 30/1521 | 98407743 | 30/186 |
| 2303350 | 30/2117 | 7482497194 | 30/1520 | 98407744 | 30/186B |
| 2303352 | 30/2116 | 7482540378 | 30/2624 | 99485357 | 30/751 |
| 2303352 | 30/1734 | 7482540380 | 30/2623 | 99485358 | 30/752 |
| 2303355 | 30/2116 | 7484561609 | 30/1521 | 99487780 | 30/1566 |
| 2997181 | 30/146B | 7484561621 | 30/1520 | 99487780 | 30/748 |
| 2997182 | 30/146 | 7700351293 | 30/208B | 99487781 | 30/1567 |
| 2997183 | 30/179 | 7700351294 | 30/208 | 99487781 | 30/749 |
| 2997184 | 30/179B | 7700352494 | 30/1006 | A0007200079 | 30/2616 |
| 2997193 | 30/751 | 7700352495 | 30/1005 | A0007200079 | 30/1777 |
| 2997194 | 30/752 | 807000T000 | 30/1816 | A0007200179 | 30/2615 |
| 2997195 | 30/1566 | 807010T000 | 30/1817 | A0007200179 | 30/1776 |
| 2997195 | 30/748 | 81626456052 | 30/2074 | A0007250002 | 30/2616 |
| 2997196 | 30/1567 | 81626456053 | 30/2075 | A0007250002 | 30/1777 |
| 2997196 | 30/749 | 81626456054 | 30/1778 | A0007250102 | 30/2615 |
| 3176541 | 30/2119 | 81626456055 | 30/1779 | A0007250102 | 30/1776 |
| 3176542 | 30/2118 | 8200162708 | 30/1006 | A9607201646 | 30/2188 |
| 42565948 | 30/1670 | 8200162710 | 30/1005 | A9607201746 | 30/2189 |
| 42565949 | 30/1671 | 8200467967 | 30/1005C | A9737200346 | 30/1773 |
| 42574132 | 30/1006C | 8200467967 | 30/1670 | A9737200446 | 30/1772 |
| 42574133 | 30/1005C | 8200467971 | 30/1006C | | |
| 4644622 | 30/69 | 8200467971 | 30/1671 | | |
| 4644623 | 30/70 | 82497193 | 30/1521 | | |
| 4817018 | 30/185 | 82497194 | 30/1520 | | |
| 4817019 | 30/185B | 84225944 | 30/2660 | | |
| 4817201 | 30/746 | 84225953 | 30/2659 | | |